

High–Wall Duct–Free Split systems

PA13A / PW3CA Cooling Sizes 009–012

PA13N / PW3CN Cooling Sizes 012–024

PH13A / PW3HA HP Sizes 009–012

PH13N / PW3HN HP Sizes 012–024

Owner's Manual

TABLE OF CONTENTS

	PAGE
SAFETY PRECAUTIONS	2
GENERAL	2
PART NAMES	3
DISPLAY PANELS	4
REMOTE CONTROL	5
REMOTE CONTROL FUNCTIONS	6 - 8
CLEANING, MAINTENANCE AND TROUBLESHOOTING	9 - 10

NOTE TO EQUIPMENT OWNER:

Please read this Owner's Information Manual carefully before installing and using this appliance and keep this manual for future reference.

For your convenience, please record the model and serial numbers of your new equipment in the spaces provided. This information, along with the installation data and dealer contact information, will be helpful should your system require maintenance or service.

UNIT INFORMATION

Model # _____

Serial # _____

INSTALLATION INFORMATION

Date Installed _____

DEALERSHIP CONTACT INFORMATION

Company Name: _____

Address: _____

Phone Number: _____

Technician Name: _____

SAFETY PRECAUTIONS

WARNING

PERSONAL INJURY, DEATH, OR PROPERTY DAMAGE HAZARD

Failure to follow this warning could result in personal injury, death, or property damage.

Read and follow all instructions and warnings, including labels shipped with or attached to unit before operating your new air conditioner.

Any time you see this symbol  in manuals, instructions and on the unit, be aware of the potential for personal injury. There are three levels of precaution:

DANGER identifies the most serious hazards which will result in severe personal injury or death.

WARNING signifies hazards that could result in personal injury or death.

CAUTION is used to identify unsafe practices which would result in minor personal injury or product and property damage.

NOTE is used to highlight suggestions which **will** result in enhanced installation, reliability, or operation.

WARNING

PERSONAL INJURY, DEATH AND / OR PROPERTY DAMAGE HAZARD

Failure to follow this warning could result in personal injury, death or property damage.

Improper installation, adjustment, alteration, service, maintenance, or use can cause explosion, fire, electrical shock, or other conditions which may cause personal injury or property damage.

Consult a qualified installer, service agency, your distributor or branch for information or assistance. The qualified installer or service agency must use factory-authorized kits or accessories when modifying this product.

GENERAL

The high wall fan coil unit provides quiet, maximum comfort. In addition to cooling and/or heating, the high wall fan coil unit matched with an outdoor condensing unit will filter and dehumidify the air in the room to provide maximum comfort.

IMPORTANT: The high wall fan coil unit should be installed by authorized personnel only; using approved tubing and accessories. If technical assistance, service or repair is needed, contact the installer or call 1-800-417-2963.

The high wall fan coil unit can be set up and operated from the remote control (provided). **If the remote is misplaced, the system can be operated from the “Auto” setting on the unit.**

Operating Modes:

The high wall fan coil unit has five operating modes.

- Fan only
- Auto (heat pump models only)
- Heating (heat pump models only)
- Cooling
- Dehumidification (DRY)

Fan Only

In Fan Only mode, the system filters and circulates room air without changing room air temperature.

Auto

In Auto mode, the system will automatically cool or heat the room according to the user-selected set point.

Heating

In Heating mode, the system heats and filters room air.

Cooling

In Cooling mode, the system cools, dries and filters room air.

Dehumidification (DRY)

In Dehumidification mode, the system dries, filters and slightly cools room air temperature. This mode **does not** take the place of a dehumidifier.

Remote Control

The remote control transmits commands to set up and operate the system. The control has a window display panel that shows the current system status. The control can be secured to a surface when used with the mounting bracket provided.

UNIT DISPLAY PANELS

NOTE: The display panel on the indoor unit will look like one of the following. Some of the functions will appear on the display panel, remote control or both.

On the Unit:

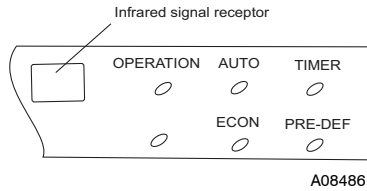

9K

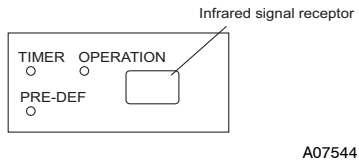

12K

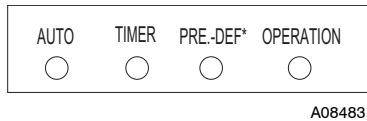

18K - 24K

*PRE-DEF light will illuminate when the unit is running in FAN ONLY mode on Cooling Only units.

Note: Cooling only units have same LED lights but without PRE-DEF print.

OPERATION:

This indicator flashes once per second after power is on and illuminates when the unit is in operation.

TIMER:

This indicator illuminates when TIMER is set ON or OFF.

PRE.-DEF indicator (heat pump units only):

Pre-Def indicator illuminates when the coil is warming up to prevent cold blow or when unit goes into defrost mode.

AUTO indicator:

When air conditioner is set to AUTO mode, the indicator illuminates.

FAN ONLY indicator:

When air conditioner is set to FAN ONLY mode, this indicator illuminates.

NOTE: All the pictures in this manual are for demonstration purposes only. The actual shape of your air conditioner may be slightly different, but the operation instructions are the same.

Remote Control Display

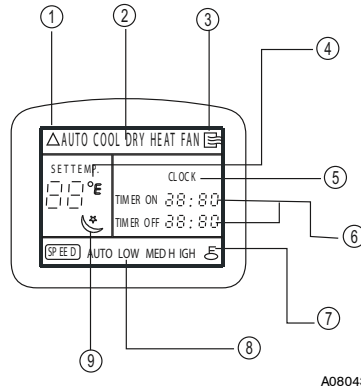

- ① **TRANSMISSION INDICATOR:** Illuminates when remote control transmits signals to the indoor unit.
- ② **MODE DISPLAY:** Indicates the current operation mode “AUTO”, “COOL”, “DRY”, “HEAT” (heat pumps only), or “FAN”.
- ③ **ON/OFF INDICATOR:** This symbol appears when the unit is turned on by the remote control, and disappear when the unit is turned off.
- ④ **TEMPERATURE DISPLAY:** Temperature setting from 62°F (17°C) to 88°F (30°C) will be displayed. If FAN mode is selected, there will be no temperature displayed.
- ⑤ **CLOCK DISPLAY:** Indicates the current time (0 to 24 hours).
- ⑥ **TIMER DISPLAY:** Indicates the set times for the timer operation (0 to 24 hours).
- ⑦ **LOCK DISPLAY:** Displays when settings are locked.
- ⑧ **FAN SPEED DISPLAY:** Indicates the set fan speed. AUTO is displayed when unit is running in AUTO or DRY mode.
- ⑨ **SLEEP DISPLAY:** Indicates unit is running in SLEEP mode.

NOTE: Symbols shown in this manual are for the purpose of demonstration. During actual operation, only the relevant symbols are displayed.

Remote Control Operation - Quick Start

NOTE: When transmitting a command from the remote control to the unit, be sure to point the control toward the right side of the unit. The unit will confirm receipt of a command by sounding an audible beep.

1. Turn the unit on by pushing the **ON/OFF** button.
2. If there is a preference for temperature settings to be displayed in °F rather than °C (default), push the recessed F/C button once using a paper clip or similar object.
3. Select the desired mode by pushing the mode button.



NOTE: Cool only units have no heat mode.

4. Select the temperature set point by pointing the control toward the unit and pressing the increase/decrease temperature set point buttons until the desired temperature appears on screen.
5. Select the desired fan speed by pressing the **FAN SPEED** button to select desired fan speed.

NOTE: If unit is operating in Dry mode, AUTO fan speed will be displayed.

6. Set the airflow direction. When the unit is turned on, the louvers default to the cooling or heating position. The user can adjust louver position by pushing the air direction button or have continuous louver movement by pushing the swing button.

Emergency Operation

If the remote control is lost, damaged, or the batteries are exhausted, the **MANUAL** button can be used to run the unit.

Open the front cover panel and press the **MANUAL** button once briefly when the system is off.

To stop emergency operation, push the **MANUAL** button **twice** and operate the remote control. If the **MANUAL** button is only pushed once, the system will enter TEST mode and run for 30 minutes.

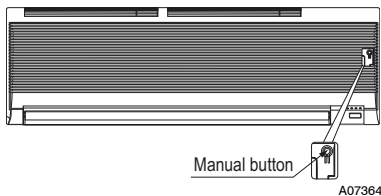

The set conditions of emergency operation are as follows:

- Preset set point: 76°F (24°C)
- Fan speed: AUTO
- Discharge air direction: Pre-set position based on operation in “Cool” or “Heat” mode.

REMOTE CONTROL FUNCTIONS

Pressing the On/Off Button

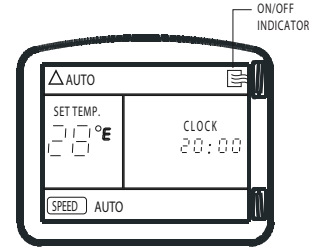

A08034

When the air conditioner is not in operation, the remote control will display the last set point, mode and time.

- Press the On/Off button to start the unit.
 - The unit will start in the last operating mode and set point. The ON/OFF indicator will appear.
- Press button On/Off to stop the unit.
 - All indicator lights on the unit will go out, and the remote control will display the set point, mode and time.

NOTE: If the On/Off button is pressed too soon after a stop, the compressor will not start for 3 minutes due to the inherent protection against frequent compressor cycling. The unit will only emit an audible beep when the signals are received correctly.

Selecting an Operating Mode

Use the Operating Mode button to select one of the available modes.

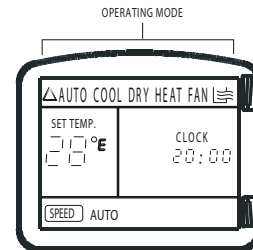

A08034 / A07548

Setting the Room Temperature Set Point

Pressing the increase temperature set point ▲ and decrease ▼ buttons will raise or lower the temperature.

The unit will confirm signal receipt with a beep and the value of the set temperature on the display will change accordingly.

The temperature can be set between 62°F (17°C) and 88°F (31°C).

NOTE: In Cooling mode, if the temperature selected is higher than the room temperature, the unit will not start. The same applies for the Heating mode if the selected temperature is lower than the room temperature.

Selecting the Fan Speed

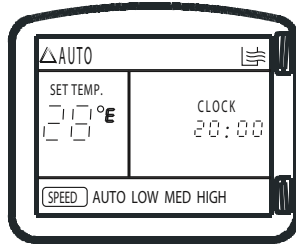

The fan speed can be selected by pressing the **FAN SPEED** button.

NOTE: When the unit is on, the fan will run continuously in cooling or heating. When in heating, there might be situations where the fan will slow down or shut off to prevent cold blow.

Selecting the Horizontal Direction Louver Position

In order to optimize comfort, the horizontal louver will operate in a preset range as shown in the figure below.

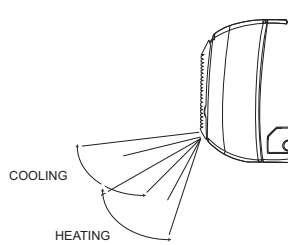

The horizontal louvers can be adjusted using the remote control and can be set to be stationary or moving continuously.

Air Direction

Press the AIR DIRECTION button repeatedly to choose one of the louver positions.

Every time the air direction button is pushed, the louver will swing by 6 degrees.

In the Cooling, Dehumidification, and Fan Only mode, the louver will swing in the cooling range. In the Heating mode, the louver will swing in the heating range.

NOTE: Always use the remote control to adjust the louver position, otherwise abnormal operation may occur. If the louver is manually adjusted out of its range, turn the unit off and then on again.

Auto Swing

To have the louver moving continuously, push the SWING button. Push again to stop the louver.

Selecting Vertical Direction of the Louver

The vertical louvers can be adjusted manually to direct the airflow to achieve the optimal comfort in the space.

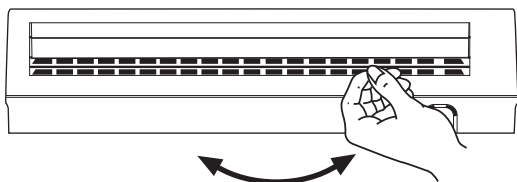

Timer Function

TIMER ON (to start the unit) and TIMER OFF (to stop the unit) can be used separately or together.

Timer ON only

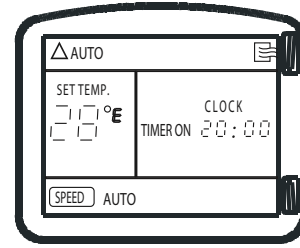

This function will allow the unit to start automatically at the set time. The TIMER ON can be set while the unit is on or off.

UNIT ON

- Press the TIMER button once. The current time flashes next to the TIMER ON display on screen. Press the temp ▲ button or temp ▼ button to set the desired "TIME ON". Every time the ▲ or ▼ button is pushed, the time increases or decreases by 10 minutes.
- When the TIMER ON is set, the TIMER light on unit illuminates. The unit will shut off and will start again at the set time.

UNIT OFF

- Set the timer described in the UNIT ON section.
- The unit will start at the set time.

To cancel TIMER setting, press the CANCEL button.

Timer OFF only

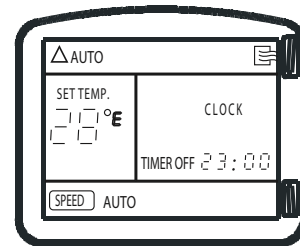

This function will allow the unit to stop automatically at the set time. The timer can be set while the unit is on or while it is off.

UNIT ON

- Press the TIMER button twice. The current time flashes next to the TIMER OFF display on screen. Press the temp ▲ button or temp ▼ button to set the desired "TIME OFF". Every time the ▲ or ▼ button is pushed, the time increases or decreases by 10 minutes.
- When the TIMER OFF is set, the timer light on the unit illuminates and the unit turns off automatically at the set time.

UNIT OFF

- Set the TIMER off as described in the UNIT ON section.
- The unit will turn on and will turn off at the set time.
- If TIMER OFF is canceled (by pushing the cancel button), before the set time elapses, the unit will continue running.

Timer ON and Timer OFF

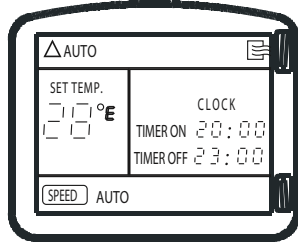

A08041

Use both functions to program the unit to turn on and shut off at specified times.

UNIT OFF

- Set TIMER ON as previously described.
- Set TIMER OFF as previously described.
- The unit will start automatically at the set TIME ON and will turn off at the set TIME OFF.

UNIT ON

- Set TIME OFF as previously described.
- Set TIME ON as previously described.
- The unit will turn off automatically at the set TIME OFF and will turn on at the set TIME ON.

Sleep Mode

This mode is used to conserve energy and can be used when the unit is in the COOL, HEAT or AUTO mode only.

Cool Mode

- Push the SLEEP button. The SLEEP display will appear on the remote control.

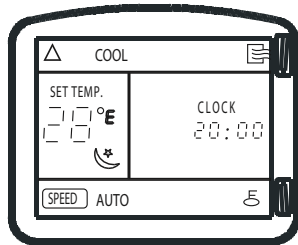

A08038

- After 1 hour the set point will be raised by 1.8°F (1°C).
- After another hour, the set point will be raised by another 1.8°F (1°C) and the fan will run in low speed.
- The unit will shut off 7 hours after setting the SLEEP mode.
- The SLEEP mode will be cancelled if any button on the remote control is pressed.

Heat Mode

- Same as cooling mode but set points will be lowered by 1.8°F (1°C).

Turbo Mode

This function is available in COOL mode on 9k and 12k cooling only units. Use the TURBO mode to cool the room rapidly.

- Press the TURBO button. An audible “beep” will be heard.
- The fan will run on high speed.
- The TURBO mode terminates automatically after 20 minutes from pushing the Turbo mode button once. It can be terminated immediately by pushing the Turbo mode again. When the Turbo mode is terminated, the unit will go back to the original setting.

Lock

Use this function to lock the settings on the remote control and to prevent the settings being changed.

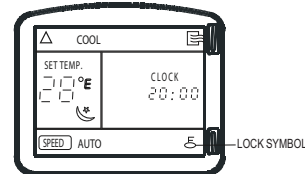

A08039

To lock and unlock the remote control, press the ▲ and ▼ temp buttons simultaneously for about 3 seconds.

Resetting the Remote Control

If the remote control is not functioning properly, it can be reset by pressing the reset button with a paper clip or tip of a pen. Current settings will be cancelled and the control will return to the initial settings and will be in standby mode. Push the ON/OFF button to activate it.

Time Delay

If the On/Off button is pressed too soon after a stop, the compressor will not start for 3 minutes due to the inherent protection against frequent compressor cycling. The unit will only emit an audible beep when the signals are received correctly.

Heating Features

If the unit is in the heating mode, there will be a delay when the fan starts. The fan will start only after the coil is warmed up to prevent cold blow.

Defrost Operation

In heating mode, if the outdoor coil is frosted, the indoor fan and outdoor fan will turn off while system removes the frost on the outdoor coil.

The system will automatically revert to normal operation when frost is removed from the outdoor unit.

Auto Start

If the power fails while the unit is operating, the unit stores the operating condition, and it will start operation automatically under those conditions when the power is restored.

CLEANING, MAINTENANCE AND TROUBLESHOOTING

CAUTION

ELECTRICAL SHOCK HAZARD

Failure to follow this caution may result in personal injury or death.

Always turn off power to the system before performing any cleaning or maintenance to the system. Turn off the outdoor disconnect switch located near outdoor unit. Be sure to disconnect indoor unit if on a separate switch

CAUTION

EQUIPMENT DAMAGE/OPERATION HAZARD

Failure to follow this caution may result in equipment damage or improper unit operation.

Operating the system with dirty air filters may damage the indoor unit and could cause reduced cooling performance, intermittent system operation, frost build-up on indoor coil or blown fuses.

Periodic Maintenance

Periodic maintenance is recommended to ensure proper operation of the unit. Recommended maintenance intervals may vary depending on the installation environment, e.g., dusty zones, etc. Refer to Table 1.

CAUTION

CUT HAZARD

Failure to follow this caution may result in personal injury.

The coil fins are very sharp. Use caution when cleaning.

Always wear safety protection.

Cleaning the Coil

Clean the coil at the beginning of each cooling season, or when necessary. Use a vacuum cleaner or a long-bristle brush to avoid damage to the coil fins.

Air Filters

Remove and clean the air filters once a month.

NOTE: If air filters show signs of excessive wear or are torn, they must be replaced. Contact your local dealer for replacement filters.

1. Open front panel on unit.
2. Pull filters down to remove.
3. Vacuum filters.
4. Clean with warm water.
5. Shake filter to remove excess water and dry thoroughly.
6. Replace filter by sliding into rack until filter snaps in place.
7. Close front panel on unit.

CAUTION

EQUIPMENT DAMAGE HAZARD

Failure to follow this caution may result in equipment damage.

When cleaning the front panel, do not use water hotter than 105°F (40.56°C) and do not pour water onto the fan coil. Do not use abrasive or petroleum based cleaners as they may damage the front panel.

Indoor Unit Front Panel

To clean the front panel on the indoor unit, wipe the outside with a soft, dry cloth. If necessary, a mild liquid detergent can be applied and wiped off with a dry cloth.

Preparing for Extended Shutdown Period

Clean the filters and reposition them in the unit. Operate the unit in Fan only mode for 12 hours to dry all internal parts.

Turn main power supply off and remove batteries from the remote control.

System Operation Recommendations

The items outlined in the following list will help to assure proper system operation:

- Replace both remote control batteries at the same time.
- Point the remote control toward the unit display panel when transmitting a command.
- Keep doors and windows closed while unit is operating.
- Contact an authorized service representative if a problem arises that cannot be easily resolved.
- Do not perform cleaning or maintenance activities while unit is on.
- Keep display panel on unit away from direct sunlight and heat as this may interfere with remote control transmissions.
- Do not block air intakes and outlets on the indoor or outdoor units.

Energy Saving Recommendations

The following recommendations will add greater efficiency to the ductfree system:

- Select a comfortable thermostat setting and leave it at chosen setting. Avoid continually raising and lowering the setting.
- Keep unit filter clean. Frequent cleaning may be necessary depending on indoor air quality.
- Use drapes, curtains or shades to keep direct sunlight from heating room on very hot days.
- Do not obstruct air intake on front panel.
- Turn on air conditioning before indoor air becomes too uncomfortable.

Troubleshooting

Refer to Table 2 before contacting your local dealer.

Table 1—Periodic Maintenance

INDOOR UNIT	EVERY MONTH	EVERY 6 MONTHS	EVERY YEAR
Clean Air Filter* Change Remote Control Batteries	•	•	•
OUTDOOR UNIT	EVERY MONTH	EVERY 6 MONTHS	EVERY YEAR
Clean Outdoor Coil from Outside Clean Outdoor Coil from Inside† Blow Air Over Electric Parts† Check Electric Connection Tightening† Clean Fan Wheel† Check Fan Tightening† Clean Drain Pan†		•	• • • • •

* Increase frequency in dusty zones.

† Maintenance to be carried out by qualified service personnel. Refer to the Installation Manual

Table 2—Troubleshooting

PROBLEM	POSSIBLE CAUSE	SOLUTION
Unit/System Does Not Work	<ul style="list-style-type: none"> The circuit breaker has tripped or a fuse has blown. Power failure. Diagnostic lights illuminate.* Voltage is too low. 	<ul style="list-style-type: none"> Reset the circuit breaker or replace the fuse with the specified replacement fuse. Restart operation when the power is restored. Call your service representative. Call your service representative.
Cooling is Not Working Properly	<ul style="list-style-type: none"> The filter is blocked with dust. Temperature is not set properly. A window or door is open. The outdoor unit is obstructed. The fan speed is too low. The operation mode is in Fan instead of Cool. 	<ul style="list-style-type: none"> Clean the air filter. Check the temperature and reset if necessary. Close the window or door. Remove the obstruction. Change the fan speed selection. Change the operating mode to Cool or reset the unit.
Heating is Not Working Properly	<ul style="list-style-type: none"> The filter is blocked with dust. Temperature is set too low. A window or door is open. The outdoor unit is obstructed. 	<ul style="list-style-type: none"> Clean the air filter. Check the temperature and reset if necessary. Close the window or door. Remove the obstruction.
Unit Stops During Operation	<ul style="list-style-type: none"> The Off timer is not operating correctly. Diagnostic lights illuminate.* 	<ul style="list-style-type: none"> Restart the operating mode. Call your service representative.

* Diagnostic lights are a combination of lights that will illuminate in the display area on the unit. They are a combination of the lights you see during normal operation.