

Installation Instructions

SAFETY CONSIDERATIONS

Installation and servicing of air-conditioning equipment can be hazardous due to system pressure and electrical components. Only trained and qualified service personnel should install, repair, or service air-conditioning equipment.

When working on equipment, observe precautions in the literature, tags and labels attached to the unit, and other safety precautions that may apply.

Follow all safety codes. Wear safety glasses and work gloves.

Recognize safety information. This is the safety-alert symbol . When you see this symbol on the unit and in instructions or manuals, be alert to the potential for personal injury.

Understand the signal words DANGER, WARNING, and CAUTION. These words are used with the safety-alert symbol. DANGER identifies the most serious hazards which **will** result in severe personal injury or death. WARNING signifies a hazard which **could** result in personal injury or death. CAUTION is used to identify unsafe practices which **may** result in minor personal injury or product and property damage. NOTE is used to highlight suggestions which **will** result in enhanced installation, reliability, or operation.

INSTALLATION

WARNING

EQUIPMENT DAMAGE HAZARD

Failure to follow this warning could result in personal injury and damage to equipment.

To prevent injuries and rain damage, do not leave roof opening uncovered. If unit installation is not completed immediately after adapter curb is installed, provide an adequate temporary cover for the roof opening.

Follow all local, state, and other applicable codes when installing the accessory roof curb adapters.

Table 1 – Package Usage

MODEL	PART NUMBER	SIZE
48/50HC	CRADCURB007A00	04-06
	CRADCURB008A00	07-12
	CRADCURB009A00	14

Table 2 – Package Contents

DESCRIPTION	QTY
Fully Assembled Curb Adapter	1
Gasket	1
Bag of Screws	1

FEATURES

- Fully assembled curb adapter.
- Includes internal duct transitions.
- Internally insulated with 1” - 1.5” insulation. Gasketing package provided.
- Adapter pans and supports provided/field installed.

CURB ADAPTER INFORMATION

- To verify that the curb adapter shown in Fig. 2 - Fig. 4 is the correct adapter for your job, be sure the existing curb is the same size as dimensions provided. (The bottom dimensions of the curb adapter are larger than existing curb outside dimensions.)
- Before the new HVAC unit is set in place, inspect structural stability of existing curb and building’s roof load capability. Reinforce if required.
- All curb adapters will increase the systems external static pressure and must be included when calculating unit requirements. Curb adapters are designed to attach to an existing curb with side x side duct connections. The curb adapter is not designed for use with concentric duct configuration.
- No calculations are available for this product. For calculated product, please contact factory for part number, pricing and lead time.
- Please contact the factory for more detailed dimensional information, if required. Designs are based on standard factory dimensions, and may differ in the field.

Step 1 — Locating the Horizontal Curb Adapter

There are many things to consider when locating the Horizontal Curb Adapter/ERV unit, including:

1. Structural support required from roof system.
2. Duct drop location in relation to joists.
3. Serviceability of the ERV unit.

- 4. Clearances required on the ERV unit.
- 5. Locations of vents or other sources of contaminated air which could negatively affect the quality of the outside air entering the ERV unit.

Step 2 — Applying Gasket

Apply the supplied gasket to the entire upper perimeter of your roof curb and around the supply and return openings where the curb adapter and roof curb mate. Gasket strips must fit tightly together, leaving no gaps for leakage.

IMPORTANT: Gasketing is critical for water integrity. Improperly installed gasketing can result in air leaks and poor unit performance.

Step 3 — Aligning the Horizontal Adapter Curb

Align the proper airflow paths in the curb adapter to those in your roof curb. Lower the curb adapter slowly into place, making sure the gasket is not damaged.

NOTE: If any gasket is damaged, it must be replaced to ensure a proper seal.

Step 4 — Securing the Adapter Curb

Once the adapter curb has been safely lowered into place, the two pieces need secured together. Using the provided screws, insert a screw every 24” from the side, as shown in Fig. 1.

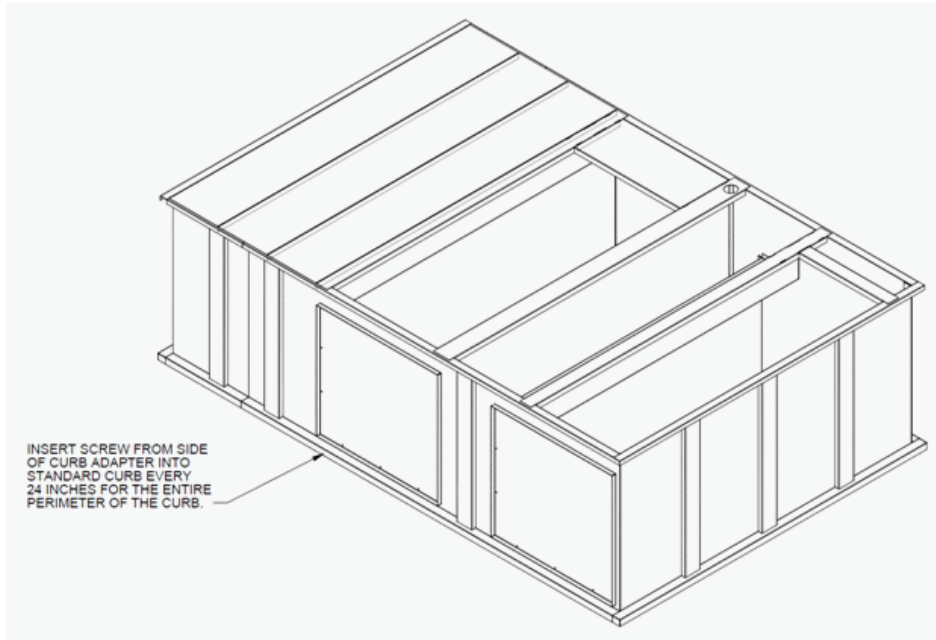
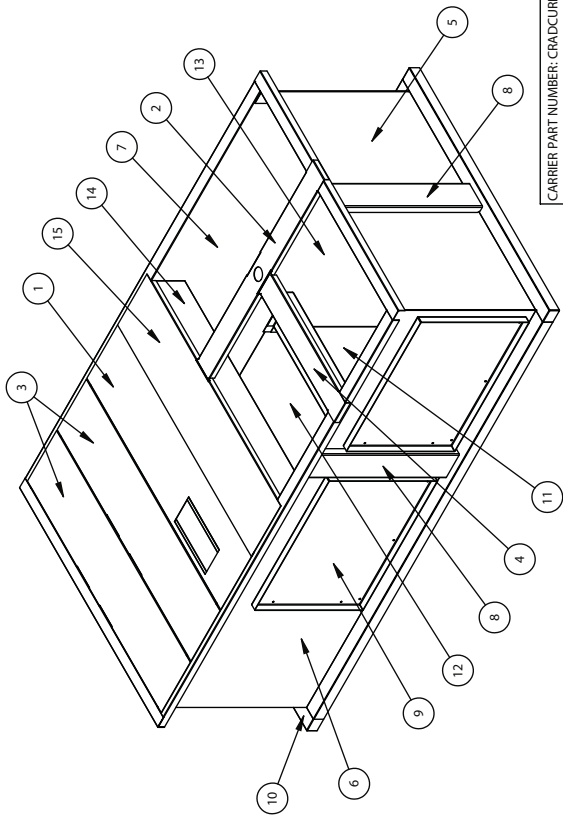

Fig. 1 - Securing the Adapter Curb

C12176



CARRIER PART NUMBER: CRADCURB007A00
 MICROMETL PART NUMBER: HJ36-W-HCRB
 INSTALL INSTRUCTION # IIK-CRADCURB07-01

ITEM NO.	M/MC PART NO.	DESCRIPTION	QTY.
1	0537043D	DECK PAN-B	1
2	0537052E	R/A DUCT SUPPORT	1
3	0537053B	DECK PAN-A	2
4	0537054B	S/A DUCT SUPPORT	1
5	CRBHJ0020	FRONT PANEL	1
6	CRBHJ0021	SIDE A	1
7	CRBHJ0022	SIDE B	1
8	CRBHJ0023	VERTICAL SUPPORT	6
9	CRBHJ0025	COVERS	2
10	CRBHJ0027	BACK PANEL	1
11	CRBHJ0028	SUPPLY SHROUD A	1
12	CRBHJ0029	FLOOR	1
13	CRBHJ0030	SUPPLY SHROUD B	1
14	CRBHJ0031	RETURN SHROUD A	1
15	CRBHJ0033	DECK PAN-C	1

SIZE	D
DRAWING NUMBER	48TM404345
REV	A

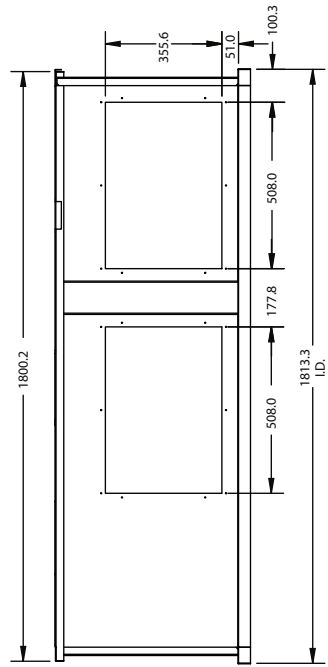
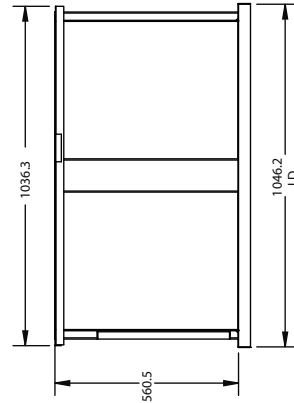
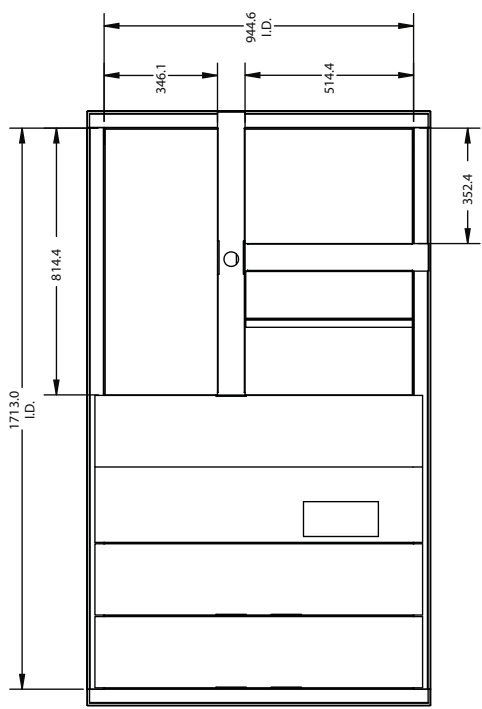

- NOTES:
 1. CURBS FULLY WELDED
 2. INSULATED DECKPANS
 3. INCLUDES L/EOF 1-1/2 X 1/4" GASKETING (9430-0100)
 4. WILL SIT ON STANDARD CURB

Fig. 2 - CRADCURB007A00 Horizontal Curb Adapter Assembly

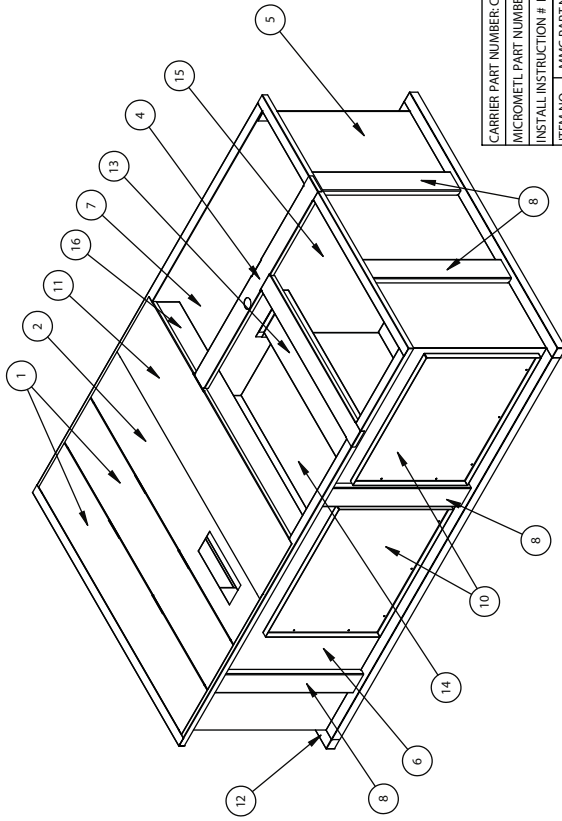

CARRIER PART NUMBER: CRADCURB008A00			
MICROMETL PART NUMBER: HJ712-W-HCRB			
INSTALL INSTRUCTION # IIK-CHADCURBD7-01			
ITEM NO.	MMC PART NO.	DESCRIPTION	QTY.
1	0597101A	DECK PAN-A	2
2	0597102C	DECK PAN-B	1
3	0597105A	SUPPORT, SUPPLY	1
4	0597106A	SUPPORT, RETURN	1
5	CRBHJ0001	FRONT	1
6	CRBHJ0002	SIDE A	1
7	CRBHJ0003	SIDE B	1
8	CRBHJ0005	VERTICAL SUPPORT	10
9	CRBHJ0006	EXTENSION VERTICAL SUPPORT	1
10	CRBHJ0012	COVERS	2
11	CRBHJ0013	DECK PAN-C	1
12	CRBHJ0014	REAR	1
13	CRBHJ0015	SUPPLY SHROUD A	1
14	CRBHJ0016	FLOOR	1
15	CRBHJ0017	SUPPLY SHROUD B	1
16	CRBHJ0018	RETURN SHROUD A	1
17	CRBHJ0019	BASE RAIL EXTENSION	1

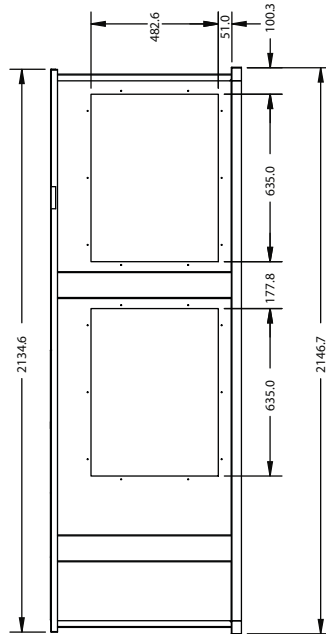
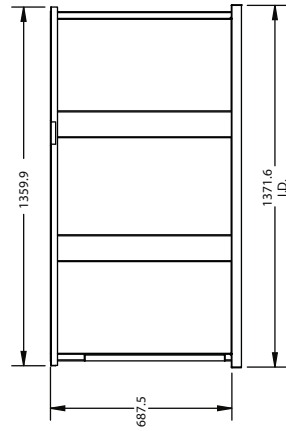
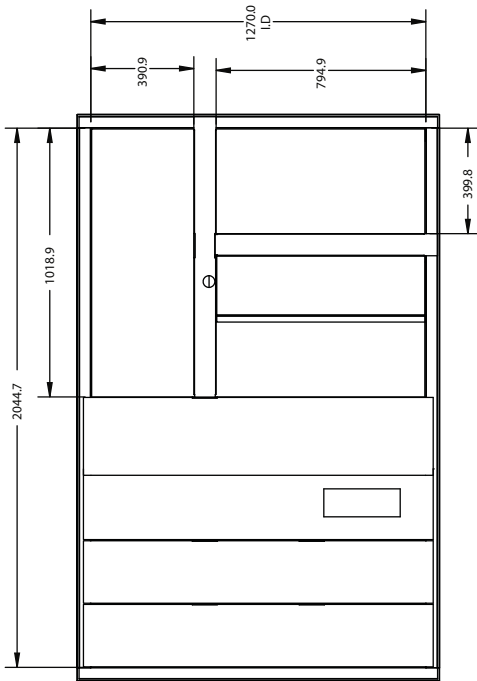

SIZE	DRAWING NUMBER	REV
D	48TMA04345	A

- NOTES:
1. SHIPS FULLY WELDED
 2. INSULATED DECK PANS
 3. INCLUDE 25 L/F OF 1-1/2 X 1/4" GASKETING (9430-0100)
 4. WILL SIT ON STANDARD CURB

Fig. 3 - CRADCURB008A00 Horizontal Curb Adapter Assembly

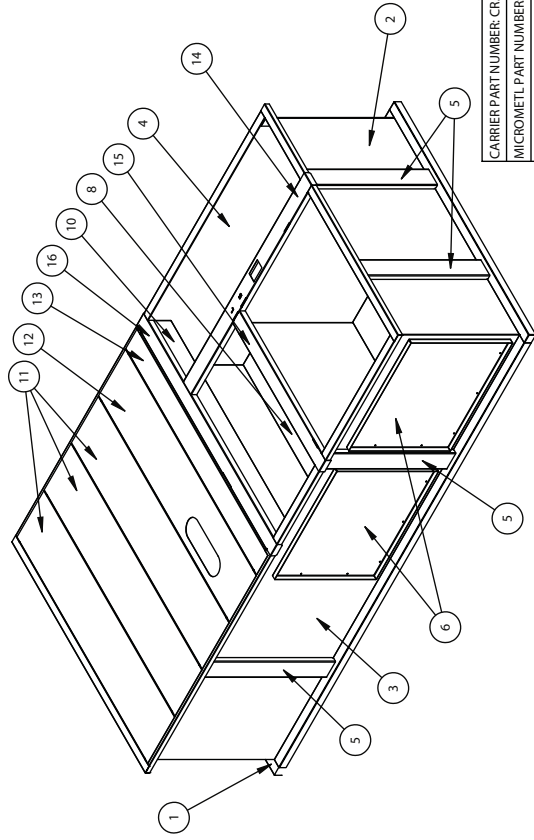

CARRIER PART NUMBER: CRADCURB009A00			
MICROMETL PART NUMBER: HEZL-W-HCRB			
INSTALL INSTRUCTION # IK-CRADCURB07-01			
ITEM NO.	M/MC PART NO.	DESCRIPTION	QTY.
1	CRBHEZL0008	REAR	1
2	CRBHEZL0001	FRONT	1
3	CRBHEZL0002	SIDE A	1
4	CRBHEZL0003	SIDE B	1
5	CRBHEZL0004	VERTICAL SUPPORT	10
6	CRBHEZL0006	COVERS	2
7	CRBHEZL0009	SUPPLY SHROUD A	1
8	CRBHEZL0010	FLOOR	1
9	CRBHEZL0011	SUPPLY SHROUD B	1
10	CRBHEZL0012	RETURN SHROUD A	1
11	CRB1457A	DECK PAN C	3
12	CRB1455A	DECK PAN A	1
13	CRB1456A	DECK PAN B	1
14	CRB1451A	SUPPORT B	1
15	CRB1453A	SUPPORT D	1
16	CRB1452A	SUPPORT C	1

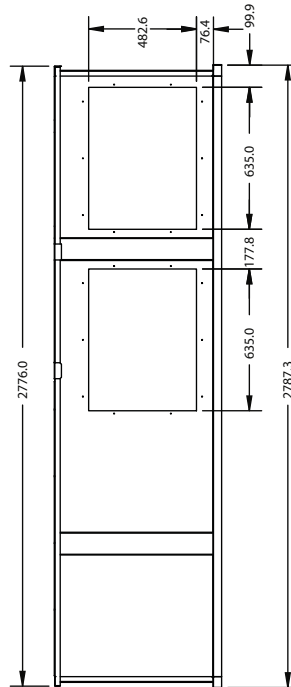
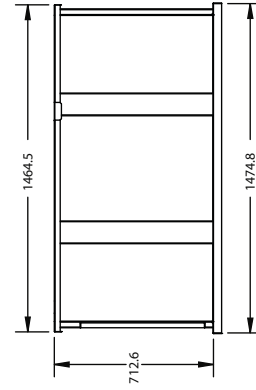
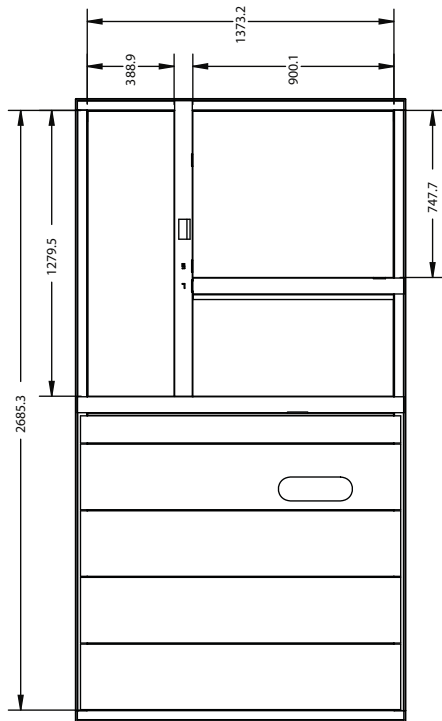

- NOTES:
1. SHIPS FULLY WELDED
 2. INSULATED DECK PANS
 3. INCLUDE 25 L/F OF 1-1/2 X 1/4" GASKETING (Ø430-0100)
 4. WILL SIT ON STANDARD CURB

SIZE	DRAWING NUMBER	REV
D	48TM40345	A

Fig. 4 - CRADCURB009A00 Horizontal Curb Adapter Assembly

