

SHRMe VRF Outdoor Unit MMY-AP240S6FT6P-UL - Heat Recovery

TOSHIBA
Carrier

Submittal Data

Job Data _____ Location _____
 Buyer _____ Buyer PO # _____ Carrier # _____
 Unit Number _____ Model Number _____
 Performance Data Certified By _____ Date _____



SHRMe VRF Heat Recovery Features

- Two 10-ton modules are combined to form a 20-ton system
- Capable of simultaneous cooling and heating (flow selector boxes required)
- Modules have 2 inverter-driven twin rotary compressors
- Backup capability due to multiple compressors
- Compressor speed varied in 0.1 Hz increments for comfort and efficiency
- Direct drive, inverter-driven 64-step outdoor motor
- Up to 3281 ft (1000 m) actual total system piping (liquid line)
- Up to 591 ft (180 m) actual piping length from outdoor unit to furthest fan coil
- Up to 330 ft (100 m) outdoor control wiring
- Up to 6560 ft (2000 m) control wiring between outdoor and indoor units
- Operating temperature range
Cooling (db): 14 to 122 F (-10 to 50 C)
Heating (wb): -13 to 60 F (-25 to 15.6 C)
- Protection: high pressure switch, low pressure sensor and switch, PC board fuse, inverter overload protection
- 7-year compressor limited warranty, 5-year parts limited warranty

Header Unit Model	MMY-MAP1206FT6P-UL	
Follower Unit Model	MMY-MAP1206FT6P-UL	
PERFORMANCE		
Nominal Cooling Capacity	Btu/h	240,000
Nominal Heating Capacity	Btu/h	270,000
Maximum Total Connected Indoor Unit Capacity		Up to 150%
SIMULTANEOUS COOLING AND HEATING EFFICIENCY*		
SCHE, Ducted FCUs		28.70
SCHE, Ductless FCUs		29.00
COOLING EFFICIENCY*		
EER/IEER, Ducted FCUs		11.00/22.50
EER/IEER, Ductless FCUs		11.00/23.50
HEATING EFFICIENCY*		
COP at 47 F, Ducted FCUs		3.50
COP at 47 F, Ductless FCUs		3.50
Fan Type (Qty)		Propeller (2)
Airflow, Standard Range	CFM	7700 + 7700
Combined System Sound Pressure, Cooling/Heating	dBA	65/67
External Static Pressure†	in. wg	0.16
ELECTRICAL		
Power Supply	V/Ph/Hz	460/3/60
Minimum Circuit Amps (MCA)**	A	22 + 22
Recommended Fuse Size**	A	25 + 25

LEGEND

db	—	Dry Bulb
COP	—	Coefficient of Performance
EER	—	Energy Efficiency Ratio
FCU	—	Fan Coil Unit
IEER	—	Integrated Energy Efficiency Ratio
SCHE	—	Simultaneous Cooling and Heating Efficiency
wb	—	Wet Bulb

COMPRESSORS		
Type (Number)		Inverter Twin Rotary (4)
Motor Output	kW	2 x 4.0 + 2 x 4.0
FAN MOTOR		
Motor Type (Steps)		Inverter Direct Driven (64)
Motor Output	kW	1.0 + 1.0
PHYSICAL DATA		
Main Pipe Connection Size - Liquid (High Pressure)††	in.	7/8 (Flare)
Main Pipe Connection Size - Gas (Low Pressure)†††	in.	1-3/8 (Brazed)
Main Discharge (High Pressure)††	in.	1-1/8 (Flare)
Balance	in.	3/8 (Flare)
Refrigerant		R-410A
Factory Charge***	lb	2 x 24.3
External Finish		Munsell 1Y8.5/0.5
Header Unit/Follower Unit Width	in.	47.6 / 47.6
Header Unit/Follower Unit Height	in.	72.9 / 72.9
Header Unit/Follower Unit Depth	in.	30.7 / 30.7
Header Unit/Follower Unit Net Weight	lb	684 + 684
REQUIRED ACCESSORY		
Connection Kit		RBM-BT14FUL

*Rated per AHRI (Air-Conditioning, Heating and Refrigeration Institute) 1230 Standard.

Cooling: Indoor 80 F (35 C) db/67 F (27 C) wb; Outdoor 95 F (35 C) db

Heating: Indoor 70 F (21 C) db; Outdoor 47 F (8 C) db/43 F (6 C) wb

†Requires setting by DIP switches.

**Separate power supply is required. MCA and fuse size for both units are given.

††Main pipe size leaving connection kit.

***Additional charges required.

NOTE: Unit cabinet and coil slab shall be capable of withstanding 500-hour salt spray test in accordance with the ASTM (American Society for Testing and Materials, U.S.A.) B-117 Standard.

Manufacturer reserves the right to discontinue, or change at any time, specifications or designs without notice and without incurring obligations.

DIMENSIONAL DRAWING OUTDOOR UNIT COMBINATION HEAT RECOVERY MMY-AP240S6FT6P-UL

Two units connected

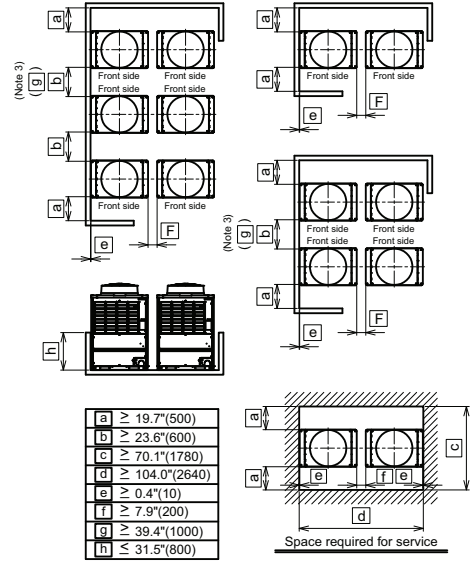
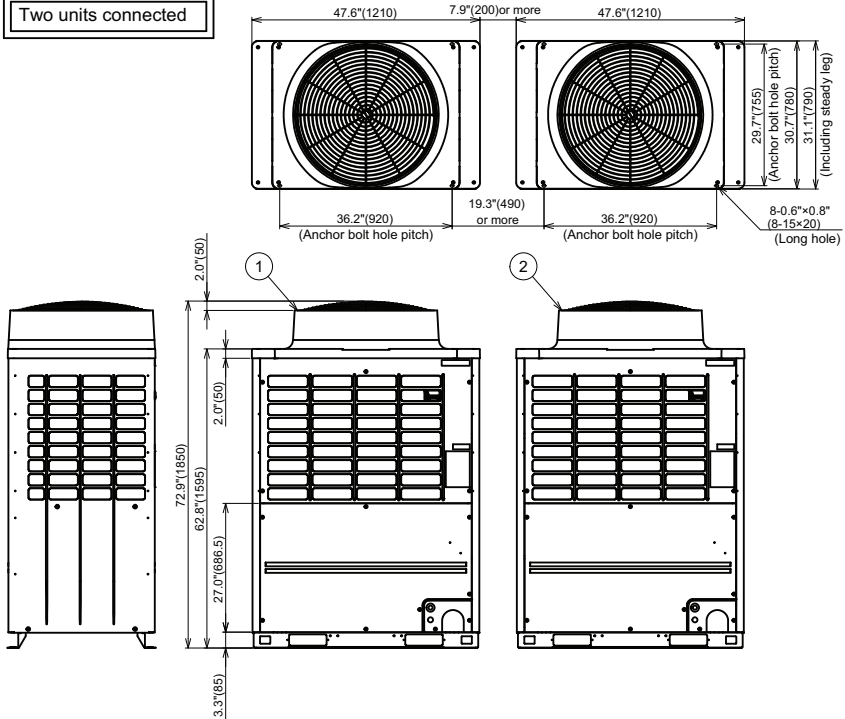

- NOTES:
- If there is an obstacle at the upper side of the outdoor unit, set the top end of the outdoor unit 78.7 in. (2000 mm) apart from the obstacle.
 - Limit the height of the obstacle surrounding the outdoor unit to 31.5 in. (800 mm) or less from the bottom end of the outdoor unit.
 - Draw out the pipe procured locally to the front of the outdoor unit horizontally, and keep 19.7 in. (500 mm) or more between the outdoor unit and traversing pipe if placing pipe transversely.
 - Arrange each outdoor unit in order of its capacity.
(Header unit ① ≥ Follower unit ②)
 - Dimensional drawing of corrosion protection and corrosion heavy protection model is the same as that of standard model.
 - Dimensions are in inches (mm).

MODEL	OUTDOOR UNIT	
	HEADER UNIT ①	FOLLOWER UNIT ②
MMY-AP240S6FT6P-UL	MMY-MAP1206FT6P-UL	MMY-MAP1206FT6P-UL

DIMENSIONAL DRAWING OUTDOOR UNIT HEAT RECOVERY/SINGLE UNIT MMY-MAP1206FT6P-UL

NOTES:

1. If there is an obstacle at the upper side of the outdoor unit, set the top end of the outdoor unit 78.7 in. (2000 mm) apart from the obstacle.
2. Limit the height of the obstacle surrounding the outdoor unit to 31.5 in. (800 mm) or less from the bottom end of the outdoor unit.
3. Draw out the pipe procured locally to the front of the outdoor unit horizontally, and keep 19.7 in. (500 mm) or more between the outdoor unit and traversing pipe if placing pipe transversely.
4. Dimensions are in inches (mm).

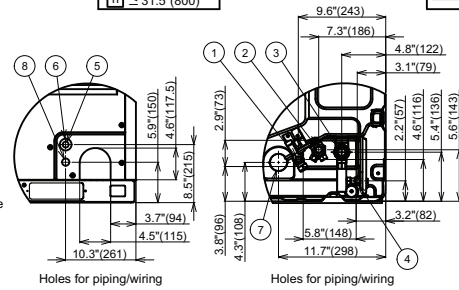
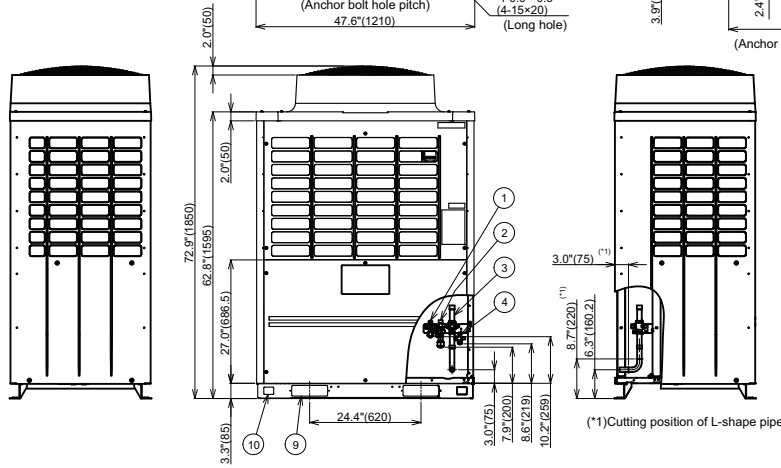
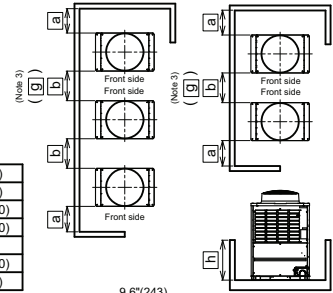
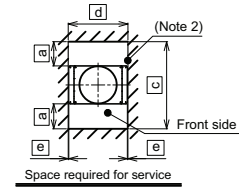
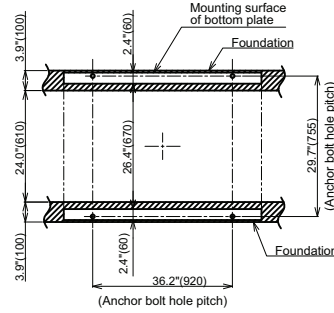
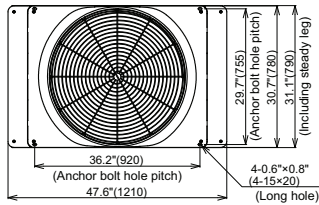

No.	Parts name	Remarks
①	Liquid pipe connection port	φ 1/2"(12.7)
②	Discharge gas pipe connection port	φ 3/4"(19.1)
③	Suction gas pipe connection port	φ A
④	Balance pipe connection port	φ 3/8"(9.5)
⑤	Knockout hole for power wiring 1	φ 0.9"(22.2)
⑥	Knockout hole for power wiring 2	φ 1.7"(43.7)
⑦	Knockout hole for power wiring 2	φ 1.9"(48)
⑧	Knockout hole for control wiring	φ 1.1"(27)
⑨	Square hole (for freight handling)	4-2.4×7.9(4-60×200)
⑩	Square hole (for hanging)	4-1.6×2.2(4-40×55)

Model Name	A
MAP 0966 type	1/2"(12.7)
MAP 1206 type	5/8"(15.9)

