



Installation Instructions

Part No. 00EFN900003200A

CONTENTS

	Page
SAFETY CONSIDERATIONS	1
GENERAL	1
INSTALLATION	1-5
Configuration (All Sizes)	2
Test Pump Control Output	2

SAFETY CONSIDERATIONS

Installing, starting up, and servicing air-conditioning equipment can be hazardous due to system pressures, electrical components, and equipment location.

Only trained, qualified installers and service technicians should install, start up, and service this equipment.

When working on air-conditioning equipment, observe precautions in the literature, on tags, stickers, and labels attached to the equipment.

Follow all safety codes. Wear safety glasses and work gloves. Use care in handling and installing this accessory.

WARNING

Be sure power to equipment is shut off before performing installation, maintenance or service. Lock out and safety-tag all disconnects. Be aware that there may be more than one disconnect. Serious personal injury from electric shock could result.

GENERAL

This accessory provides required components to integrate control of an external pump into the 30XA chiller control. As part of the chiller control, the pump will be commanded on or off based on the chiller operation. The pump will also be monitored through the chiller control for its status. Any corresponding alarms will be reported if the pump does not operate normally.

One accessory package is required for 30XA080-500 units.

INSTALLATION

Examine the package contents for correct part numbers. If any of the components are missing or damaged, file a claim with the shipping company and notify your Carrier representative. See Table 1 for accessory package contents. Refer to Fig. 1-3 for wiring details, and see Fig. 4 and 5 for board mounting locations.

The following material is field-supplied:

- 18 AWG (American Wire Gage) wires for pump control wiring
- Wire terminals and wire ties

Table 1 — Accessory Package Contents

ITEM NO.	DESCRIPTION	PART NO.	QUANTITY
1	Pump Board	32GB500432E	1
2	Harness Assembly	TH70400864	1
3	24 V Circuit Breaker (CB14)	HH83ZB001	1
4	No. 8 Screw	A6X10004352	4
5	Board Mounting Standoff	A6X10004434	4
6	Communication Cable Assembly	TH70400852	1
7	Wire Nut	HY89TB010	5
8	2-Pin Connector	1757019	1

To install the 30XA external pump accessory complete the following steps.

1. Disconnect unit power.
2. Set the board address switch on the pump board as shown in Fig. 2. Mount the pump board in the main control panel with the No. 8 screws. See Fig. 4 and 5 for the board mounting location.

NOTE: Mounting standoffs are required for 30XA080-122 units, 200/230, 380-v and 30XA140-500 units, all voltages.

3. Mount the 24-v circuit breaker (CB14) in the CB14 mounting hole on the display mounting bracket. See Fig. 4 and 5 for the mounting hole location. The display mounting bracket can be easily removed by loosening the four mounting screws on the corners.
4. Connect the 24-v power from TB10-X1 (30XA080-122 units, 460/575 v only) or TB11-X1 (all other units and voltages) to CB14 with a red wire in the harness assembly (Item 2). Find a 2-pin plug marked J1-11,12 with a red wire and a brown wire in the harness assembly. Connect the plug to the pump board J1. On the other end, connect the red wire from the plug to CB14 and the brown wire to TB10-X2 (30XA080-122 units, 460/575 v only) or TB11-X2 (all other units and voltages). Refer to Fig. 1.

5. Connect TB5-11, 13 to pump board CH1 and TB5-13, 15 to pump board CH2 per Fig. 2 with the harness assembly provided (Item 2). Use the pins on the back of TB5.

NOTE: If only one pump is available in the system (no backup pump), the wiring for pump board CH2 is not required.

6. For 30XA080-122, 200/230 v, 380 v and all 30XA140-500 units, disconnect the 3-pin plug on MBB (main base board) J9B (or EMM board J9A) for communication and plug it in to the pump board J9. Use the communication cable assembly (Item 6) to connect between pump board J9 and MBB J9B (or EMM board J9A when EMM board exists). The communication cable in the TH70400864 harness will not be used.

For 30XA080-122, 460 v, and 575 v units, connect the 3-pin plug of the communication cable in the harness assembly (Item 2) to the pump board J9 and splice the other end of the cable to the communication network using the

wire nuts provided (Item 7). Be sure to splice the wires with the same color together to ensure correct polarity.

7. Wire the coils of pump contactors (PMP1-A1, A2 and PMP2-A1, A2) to TB5-11 and 13 (pump 1) and TB5-13 and 15 (pump 2) as shown in Fig. 2 with field-supplied 18 AWG wires and wire terminals.

NOTE: If only one pump is available in the system (no backup pump), the wiring for PMP2 is not required.

8. Locate the main base board in the main control panel. Refer to Fig. 3. Near CH18 (J5C) of the board, there are violet and pink wires tied up outside the wire duct terminated with wire nuts. These wires are for pump auxiliary contact wiring. Remove the wire nuts and connect the two wires to the pump auxiliary contacts per Fig. 3 with field-supplied wiring. Some units may not be supplied with the J5C connector and the violet and pink wires. A 2-pin connector (Item 8) is supplied if these parts are not present. Wire the pump contactor auxiliary contacts to the 2-pin connector. Insert the 2-pin connector into MBB-J5C.

NOTE: If only one pump is available in the system (no backup pump), the wiring for PMP-2 is not required.

Configuration (All Sizes) — The control must be configured for pump control operation. Use the Navigator™ or the Touch Pilot™ display to configure the system. To configure the system with the Navigator display, follow the steps below.

1. Set the Enable/Off/Remote switch to OFF position.
2. Press ESCAPE until ‘Select a Menu Item’ is displayed on the screen. Use the arrow key to select the Configuration mode LED.
3. Press ENTER, then use the arrow key to select the sub-mode ‘OPTN,’ press ENTER.
4. Press the down arrow key until ‘PUMP’ is displayed.
5. Press the ENTER key twice. The word ‘PASS’ and ‘WORD’ will flash.
6. Press 0 1 1 1 then ENTER key so that ‘0’ flashes.
7. Use arrow keys to change value to one of the descriptions in Table 2.

Table 2 — Pump Control Configuration Options

CONFIGURATION	DESCRIPTION
0	No Pump Control
1	1 Pump Only
2	2 Pumps Auto*
3	PMP 1 Manual
4	Pump2 Manual*

*Used with dual pumps.

8. The unit is now configured for pump control.

To configure the system with the Touch Pilot display, follow the steps below.

1. Ensure the unit is in Local Off operating mode by looking at the left upper corner of the group display. If the unit is not in Local Off mode, push the Start/Stop (0/1) button to switch it to the Local Off mode.
2. Push the Main Menu button on the bottom line of display, and then follow the path **Config**→**USER** to the **USER** table.
3. Scroll down the screen by pushing scroll down button or page down button until Cooler Pumps Sequence is displayed. Push Cooler Pumps Sequence and the Point Data menu will display.
4. Push the Modify button within the Point Data menu. If the login menu displays, log in with the password of 3333, then press the OK button to confirm the input. The value of CCN variable *cpumpseq* will display. Enter 1, 2, 3, or 4 per Table 2 and press the OK button to confirm the input.
5. Push the Home button. A save confirmation menu will display. Press the OK button to confirm.
6. The unit is now configured for pump control.

Test Pump Control Output — Use the Navigator or Touch Pilot display, the instructions given in the Controls, Start-Up, Operation Service and Troubleshooting manual and the Service Test mode to verify proper operation of pump output. Be sure to turn off the fuse or circuit breaker for the pump(s) and verify that the pump contactor(s) is being energized during the test. For the Navigator display, illuminate the Service Test LED, enter the TEST mode, enable the test request, (‘T.REQ’) and test outputs (‘PMP.1,’ ‘PMP.2’). For the Touch Pilot display, from the main menu, follow the **Status**→**QCK_TST1**, enable the Quick Test, and test outputs (‘Water Exchanger Pump 1,’ ‘Water Exchanger Pump 2’). Once the outputs have been tested, the installation is complete. Return the Enable/Off/Remote contact switch to the desired position. Restore power to the pumps.

TB10-X2 (080-122 SIZES, 460/575 V)
TB11-X2 (ALL OTHER UNITS)

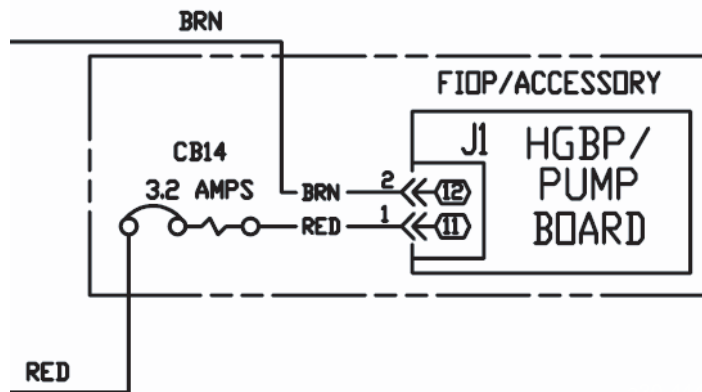

TB10-X1 (080-122 SIZES, 460/575 V)
TB11-X1 (ALL OTHER UNITS)

Fig. 1 — Pump Board 24 V Power Wiring

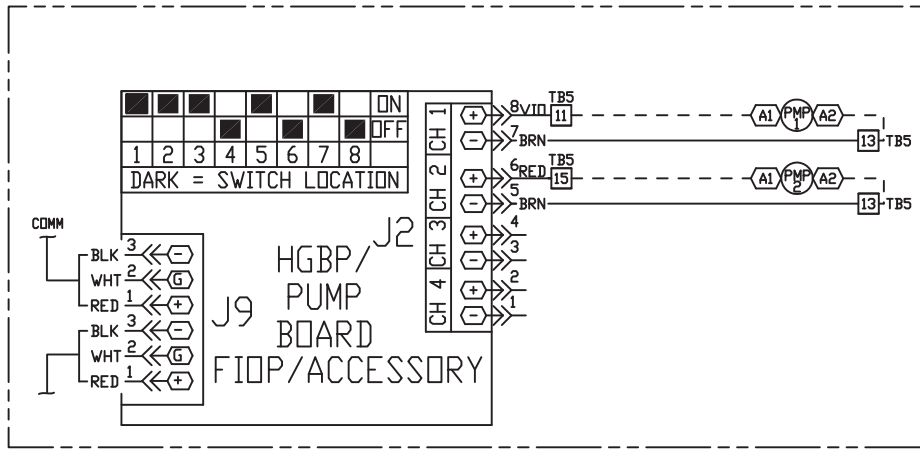

LEGEND
 - - - - Field Installed Wiring
 _____ Factory Installed Wiring

Fig. 2 — Pump Board Address Switch and Wiring for Pump Output

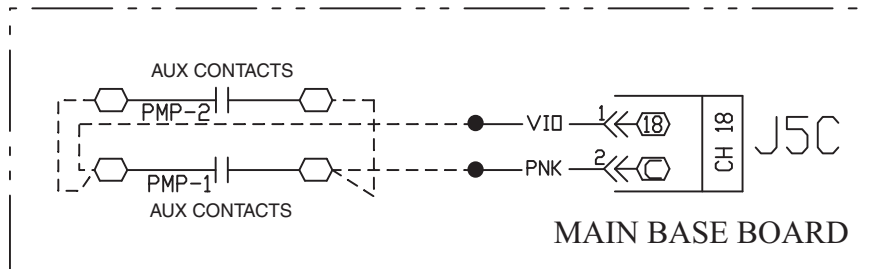

LEGEND
 - - - - Field Installed Wiring
 _____ Factory Installed Wiring

Fig. 3 — Pump Interlock Wiring on Main Base Board

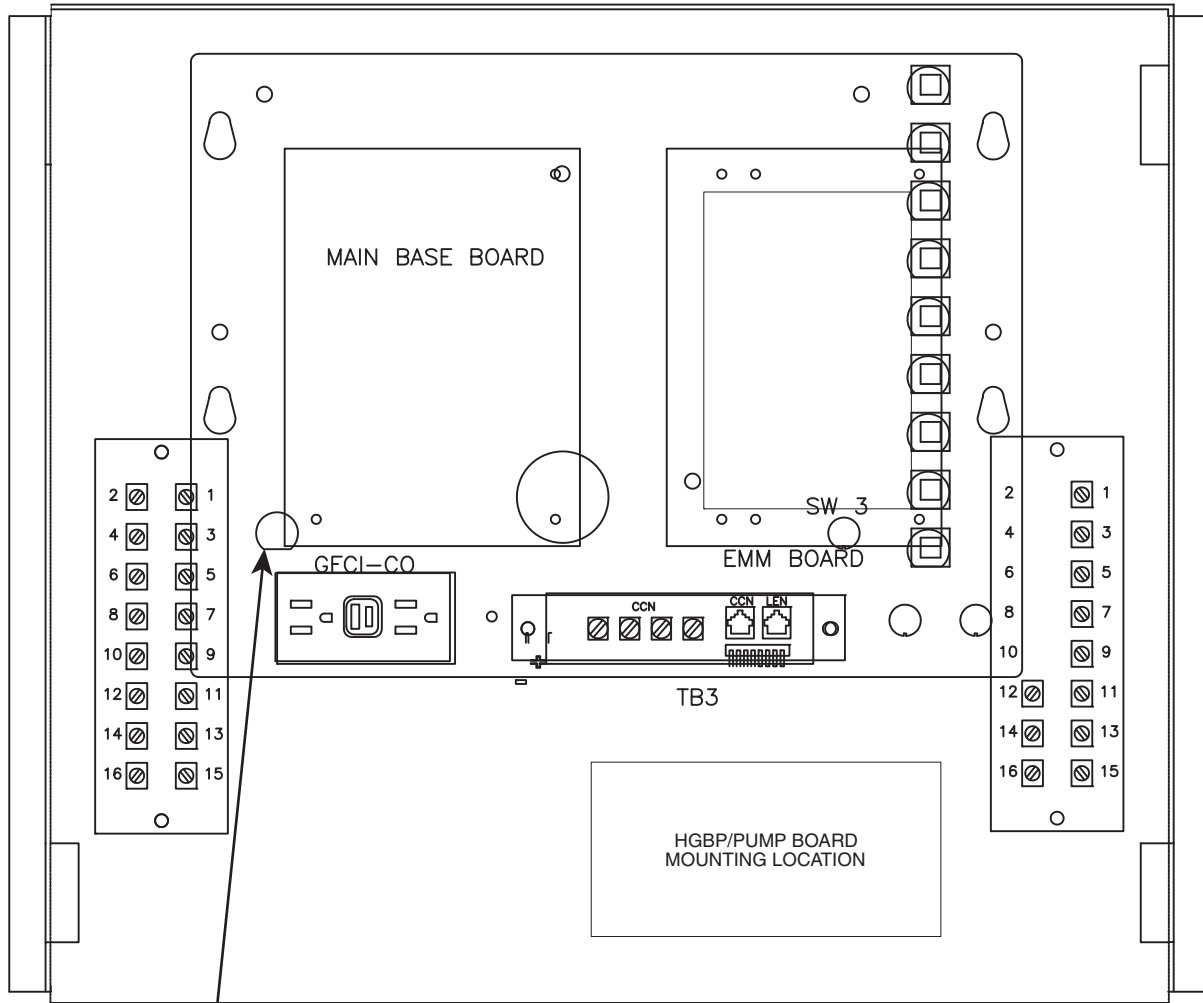

CIRCUIT BREAKER (CB14)
MOUNTING LOCATION

**Fig. 4 — Pump Board and CB14 Mounting Locations;
30XA080-122, 200/230 V, 380 V and 30XA140-500 Units, All Voltages**

CIRCUIT BREAKER (CB14)
MOUNTING LOCATION

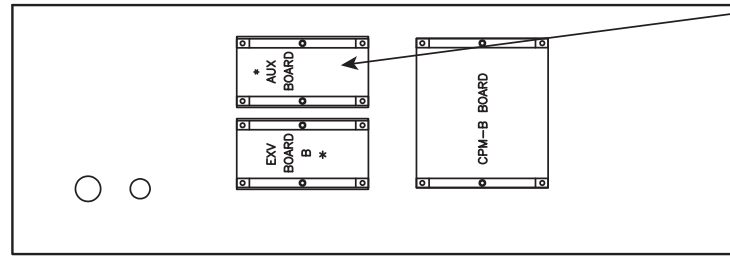
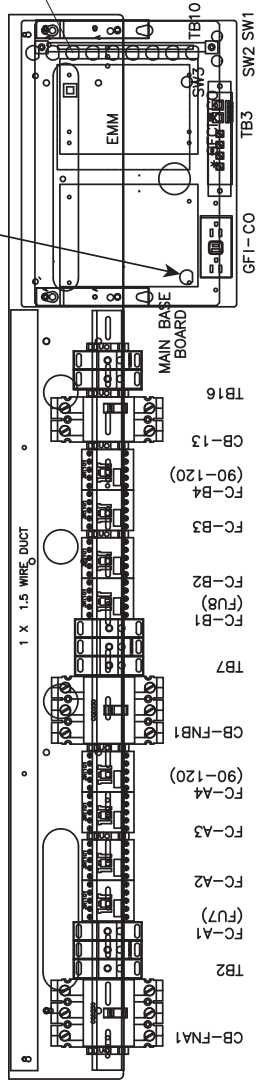
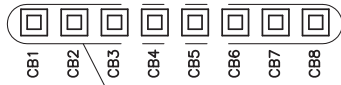

HGBP/PUMP BOARD
MOUNTING LOCATION

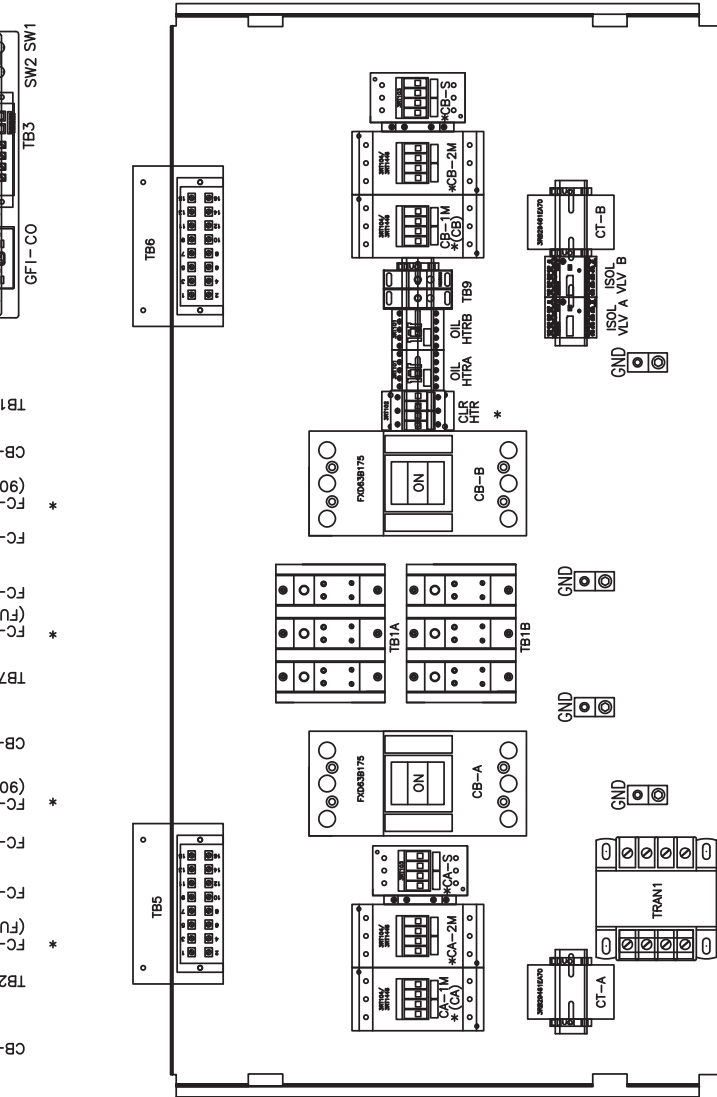

Fig. 5 — Pump Board and CB14 Mounting Location;
30XA080-122 460/575 V Units

LEGEND

- CB — Circuit Breaker
- HGBP — Hot Gas Bypass

