

SMMS-e Single VRF Outdoor Unit MMY-MAP0726HT6P-UL - Heat Pump

TOSHIBA
Carrier

Submittal Data

Job Data _____ Location _____
 Buyer _____ Buyer PO # _____ Carrier # _____
 Unit Number _____ Model Number _____
 Performance Data Certified By _____ Date _____



SMMS-e VRF Heat Pump Features

- 6, 8, 10, 12, & 14-ton modules available
- Modules have 2 inverter-driven twin rotary compressors
- Backup capability due to multiple compressors
- Compressor speed varied in 0.1 Hz increments for comfort and efficiency
- Direct drive, inverter-driven 64-step outdoor motor
- Modules can be combined to form larger systems, up to 38 tons
- 985 ft (300 m) actual total system piping (liquid line)
- 623 ft (190 m) actual piping length from outdoor unit to furthest fan coil
- Up to 330 ft (100 m) control wiring between outdoor units
- Up to 6560 ft (2000 m) control wiring between the outdoor units and indoor units
- Operating temperature range
Cooling (db): 14 to 122 F (-10 to 50 C)
Heating (wb): -13 to 60 F (-25 to 15.6 C)
- Protection: high pressure switch, low pressure sensor and switch, process controller board fuse, inverter overload protection
- 7-year compressor limited warranty, 5-year parts limited warranty

Header Unit Model	MMY-MAP0726HT6P-UL	
PERFORMANCE		
Nominal Cooling Capacity	Btu/h	72,000
Nominal Heating Capacity	Btu/h	81,000
Maximum Total Connected Indoor Unit Capacity*		Up to 150%
COOLING EFFICIENCY†		
EER/IEER, Ducted FCUs		13.70/23.40
EER/IEER, Ductless FCUs		14.80/29.00
HEATING EFFICIENCY†		
COP at 47 F, Ducted FCUs		3.88
COP at 47 F, Ductless FCUs		4.23
Fan Type (Qty)		Propeller (1)
Airflow, Standard Range	CFM	6700
Sound Pressure, Cooling/Heating	dBA	56/58
External Static Pressure**	in. wg	0.24
ELECTRICAL		
Power Supply	V/Ph/Hz	460/3/60
Minimum Circuit Amps (MCA)	A	12.9
Recommended Fuse Size	A	15

COMPRESSORS		
Type (Number)		Inverter Twin Rotary (2)
Motor Output	kW	2 x 2.1
FAN MOTOR		
Motor Type (Steps)		Inverter Direct Driven (64)
Motor Output	kW	1.0
PHYSICAL DATA		
Pipe Connection Size - Liquid (High Pressure)	in.	1/2 (Flare)
Pipe Connection Size - Gas (Low Pressure)	in.	7/8 (Brazed)
Balance	in.	3/8 (Flare)
Refrigerant		R-410A
Factory Charge††	lb	25.4
External Finish		Munsell 1Y8.5/0.5
Unit Width	in.	39
Unit Height	in.	72-7/8
Unit Depth	in.	30-11/16
Unit Net Weight	lb	574

LEGEND

db — Dry Bulb
 COP — Coefficient of Performance
 EER — Energy Efficiency Ratio
 FCU — Fan Coil Unit
 IEER — Integrated Energy Efficiency Ratio
 wb — Wet Bulb

*When total connected indoor unit capacity exceeds 135%, number and types of indoor units are limited.
 †Rated per AHRI (Air-Conditioning, Heating and Refrigeration Institute) 1230 Standard.
 Cooling: Indoor 80 F (27 C) db/67 F (20 C) wb; Outdoor 95 F (35 C) db
 Heating: Indoor 70 F (21 C) db; Outdoor 47 F (8 C) db/43 F (6 C) wb
 **Requires setting by DIP switches.
 ††Additional charge required.
 NOTE: Unit cabinet and coil slab shall be capable of withstanding 500-hour salt spray test in accordance with the ASTM (American Society for Testing and Materials, U.S.A.) B-117 Standard.

Manufacturer reserves the right to discontinue, or change at any time, specifications or designs without notice and without incurring obligations.

DIMENSIONAL DRAWING

OUTDOOR UNIT HEAT PUMP/SINGLE UNIT MMY-MAP0726HT6P-UL

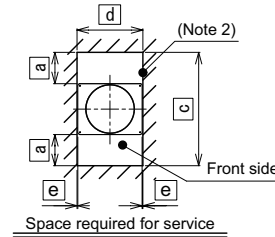
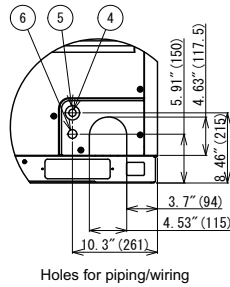
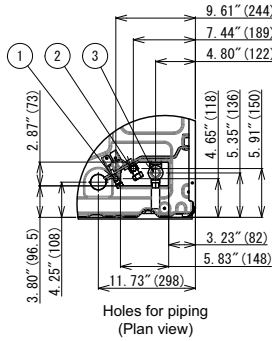
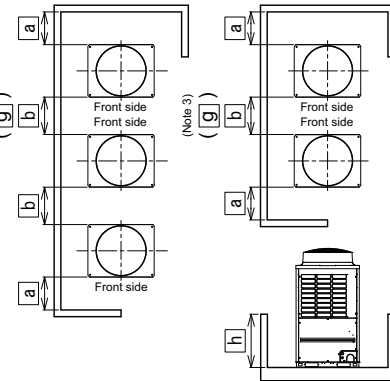
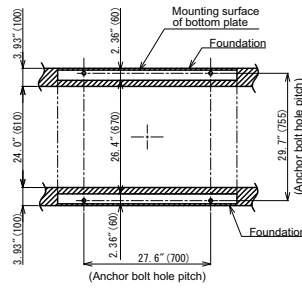
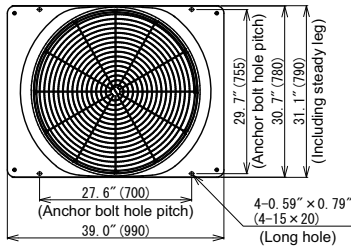

a	≥ 19.7" (500)
b	≥ 23.6" (600)
c	≥ 70.1" (1780)
d	≥ 39.8" (1010)
e	≥ 0.39" (10)
g	≥ 39.4" (1000)
h	≤ 31.5" (800)

No	Parts name	Remarks
①	Balance pipe connection port	∅3/8" (9.5)
②	Liquid pipe connection port	∅1/2" (12.7)
③	Discharge gas pipe connection port	∅1" (25.4)
④	Knockout hole for power wiring 1	∅0.87" (22.2)
⑤	Knockout hole for power wiring 2	∅1.72" (43.7)
⑥	Knockout hole for control wiring	∅1.06" (27)
⑦	Square hole (for freight handling)	4-2.36" x 7.87" (4-60 x 200)
⑧	Square hole (for hanging)	4-1.58" x 2.17" (4-40 x 55)

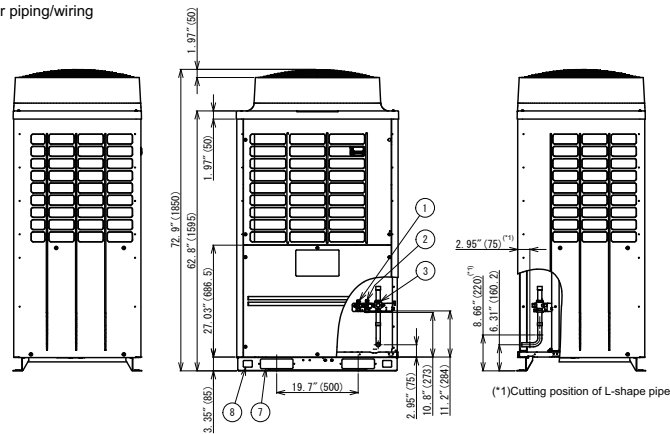

NOTES:

1. A minimum clearance of 78.7 in. (2000 mm) is required above the unit.
2. Any wall or barrier should not exceed 31.5 in. (800 mm) from the bottom of the unit.
3. The main pipe in front of the unit must extend at least a minimum of 19.7 in. (500 mm) before it can turn 90 degrees in either left or right direction.
4. Dimensions in parentheses are in millimeters.

